

Date of publication xxxx 00, 0000, date of current version xxxx 00, 0000.

Digital Object Identifier 10.1109/ACCESS.2017.Doi Number

# Partial Discharge Detection in Pressboards Immersed in Mineral Insulation Oil with Quantum Well Hall Effect Magnetic Field Sensors

Fatih Atalar<sup>1</sup>, Emrah Dokur<sup>2,3</sup>, Ertan Balaban<sup>4</sup>, Mohamed Missous<sup>4</sup> and Mukden Uğur<sup>5</sup>

<sup>1</sup>Department of Electrical and Electronics Engineering, Istanbul University Cerrahpaşa, 34320, Turkey.

<sup>2</sup>MaREI, the SFI Research Centre for Energy, Climate and Marine, University of College Cork, Cork, Ireland.

<sup>3</sup>Faculty of Engineering, Bilecik Seyh Edebali University, Bilecik, Turkey.

<sup>4</sup>Department of Electrical and Electronic Engineering, The University of Manchester, Sackville Street, Manchester M13 9PL, United Kingdom.

<sup>5</sup>Department of Electrical and Electronics Engineering, Turkish-German University, 34820, Turkey.

Corresponding author: Emrah Dokur (e-mail: edokur@ucc.ie).

**ABSTRACT** Insulation degradation may cause inefficient and faulty operation of transformers. The insulation failures in transformers mostly start with a Partial Discharge (PD) event. For both operational and cost reasons to ensure the best performance and functionality of transformers, early detection of PD events is of great importance. In this paper presents a novel PD detection technique by using a highly sensitive Quantum Well Hall Effect (QWHE) magnetic field sensor and compare the findings with an off-the-shelf silicon magnetic field transducer. The investigation of the QWHE for high voltage engineering problem such as PD detection is given first time in this paper. The aim of the study is to detect PD activity in pressboards immersed in mineral insulation oil experimentally using a new QWHE sensor. The measured experimental data from both sensors are decomposed by Empirical Mode Decomposition (EMD) and Wavelet Decomposition (WD) methods, and PD signals are analyzed comparatively. The results show that QWHE sensors provide more accurate and noise free measurements allowing early and more accurate PD detections.

**INDEX TERMS** —Empirical Mode Decomposition, Hall Effect Sensor, Partial Discharge, Quantum Well Sensor, Wavelet Decomposition.

## I. INTRODUCTION

**OPERATIONAL** reliability is an important aspect of modern power system management. System reliability heavily depends on component failures. Insulation problems caused by operation under high voltage are a major reason of physical damages and system failures.

Real time monitoring can help early detection of these problems and hence improve system reliability and reduce operational costs. In this context, determination of partial discharges (PD) in insulation materials is of great importance. For system reliability and cost reduction, especially, PD from the breakdown process of mineral oil and pressboard insulators used in transformers must be examined and modelled.

Electrical, thermal stresses and severe environmental conditions can cause degradation in dielectric properties of

the pressboard insulators and mineral oil. It is worth noting that PD does not mean total dielectric breakdown in the electrical insulation system. However, during the PD electrical charges gradually increase because of degradation in insulation properties of materials. This eventually causes a full electrical discharge making the dielectric material conductive, and hence may lead to system failure [1].

In [2] researchers used a needle-plane electrode configuration to examine this effect in mineral oil-pressboard interfaces under different voltage levels by using an Omicron MPD600 PD system and reported the correlation between interfacial polarization and static electrification. They applied a voltage between 30 kV and 40 kV to an oil impregnated pressboard insulator to investigate this effect. The moisture of the insulator is reported as 3%. Researchers have used the term "tree formation" for partial discharges

that occur on the bulk of the solid insulator, and the “tracking” for partial discharges on the surface. They also concluded that significant electrical discharges may take place in insulator without breakdown.

Surface discharges from mineral oil and pressboard interface might be an indication of serious failures [4]. Aging occurs in transformer oil as a result of electrical, thermal, mechanical stresses and structural problems that the transformer is exposed to during its operating life. Significant reductions in insulation performance of aging transformer oil may occur. Catastrophic errors were investigated in a study of 30 kV constant voltage applied to oil-impregnated paperboard insulator [5]. Researchers obtained data on the PD load-time axis every 10 minutes. It was concluded that the formation of white spots was only an initial mechanism in the process until complete discharge within the scope of the PD phenomenon, did not affect the PD values very much.

In [6] researchers investigated the effect of aging in transformer oil on PD by using three different mineral oils. In the first stage of the experiment they used pristine oil as insulator. In the second stage they used aged oil taken from a 120 MVA rated transformer with 220/110 kV which had reached the end of its operating life. The third choice was aged oil obtained by applying synthetic methods in laboratory. As one would expect, the aged oil taken from transformer was loaded with less partial discharge load.

PD detection methods can be classified as electrical and nonelectrical methods [7]. The electrical methods consist of impulse-shaped noise signal and harmonics waves. Measuring acoustic waves or heat and gas formation analysis are examples of nonelectrical PD detection methods [8]. In acoustic estimation techniques, detection of PD is highly prone to mechanical vibrations. Harmonic waves distort the magnetic field and make PD detection difficult. Magnetic field measurements can be a viable option of precision PD and its characteristics detection in transformer insulation systems. In general, electromagnetic waves formed during the sudden PD formation can be detected by various types of antennas. The electromagnetic wave generated by PD formation was detected and analyzed by using a patch antenna [9]. This antenna design used UHF sensors in order to observe wideband high frequency PD signals within the range of 300 MHz to 3 GHz. During the PD occurrence in the insulation material, different types of resonance characteristics can be observed in the generated electromagnetic wave pattern, which makes sensors calibration quite challenging. In [10] a magnetic probe-based measurement method for PD in large AC motors is presented. Although PD was detected, one obstacle encountered in this study was the size of the magnetic probe, which was not suitable to be inserted in the small gap between mineral oil and pressboard in the transformer.

The electron and ion accumulation inside the insulator leads to electron avalanches, and thereby some points of the

magnetic field signals are corrupted by noise. Examination of this corruptive signals can be used to assess and quantify the formation of partial discharges. Different methods have been proposed in the literature in order to investigate the effects of PD and corona discharges on different insulator materials [11-12].

In this paper, AC magnetic field changes in pressboard and mineral oil used as insulators in transformers has been investigated for PD analysis. For this purpose, we compared and analysed the performance of two magnetic field sensors, namely, commercially available SS49E Linear Hall Effect sensor [13] and quantum well hall effect (QWHE) magnetic field sensors developed by Advanced Hall Sensors Ltd [14]. In addition, the data received from both sensors are decomposed by Empirical Mode Decomposition (EMD) and Wavelet Decomposition (WD) methods, and PD signals are observed and analysed. We demonstrate that compared to commercial silicon parts, the QWHE sensors provide more accurate data for non-destructive analysis of PD phenomenon. In addition, a low cost PD detection and analysis method that can easily be applied to HV transformers is presented.

Section 2 presents the structure of the QWHE sensors. In Section 3 a test setup is described in detail. EMD and WD signal decomposition methods are described in detail in Section 4. Results obtained from both sensors are evaluated comparatively in the fifth and final section.

## II. QUANTUM WELL HALL EFFECT SENSORS

Hall-effect sensors are used to detect magnetic fields. Most state-of-the-art Hall-effect sensors are silicon based. This allows easy integration of sensor with conditioning electronics, which is required for both excitation and amplification. However, silicon limits the sensor sensitivity due to low carrier mobility [15]. In comparison the QWHE magnetic field sensors are based on GaAs. They have a higher carrier mobility compared to silicon that makes them more sensitive. This is achieved by formation of a Quantum Well (QW) channel that is a thin layer of a narrow band-gap semiconductor sandwiched between two larger band-gap materials [16]. Sensors used in this study are P2A model manufactured by Advanced Hall Sensors Ltd [14] and were grown by Solid Source Molecular Beam Epitaxy in a VG V90H system. A thin layer of In 0.18 Ga 0.82 As is sandwiched between two layers of Al 0.35 Ga 0.65 As and GaAs. Fig. 1 shows the structure of QWHE sensor [16].

Sensitivity of the QWHE magnetic field sensors is  $1 \mu\text{T}$  at DC and  $<10 \text{ nT}$  at higher frequencies [17]. The noise figure for QWHE sensors is similar to that of GMR and AMR sensors, but with a superior linearity, and much better dynamic range exceeding 180 dB, making these sensors a good candidate for PD analysis.

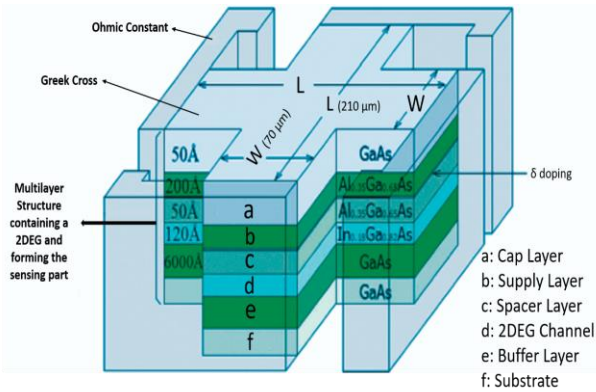

FIGURE 1. Structure of Quantum Well Hall Effect sensor

### III. EXPERIMENTAL DESIGN

#### A. TEST CONFIGURATION

The main purpose of this paper is to compare two Hall effect sensors for magnetic PD detection and analysis. In order to compare the sensitivity of these two different sensors during PD in pressboard insulator, a high voltage experiment set-up was used. The partial discharge phenomenon in a power transformer contains detection, measurement, classification, and localization. Pressboard and mineral oil are used together for protection against electrical and thermal stresses in transformers windings. PD measurements are carried out based on IEC 60641-2 (Pressboard and presspaper for electrical purposes - Part 2: Methods of tests) [17] and IEC 60270 (IEC 60270 International Standard: High-Voltage Test Techniques-Partial Discharge Measurements) [18]. The experiment is conducted on test apparatus of pressboard under the magnetic field generated by a constant high voltage AC level.

The experimental set-up consists of a high voltage apparatus. The schematic diagram of the test set-up is shown in Fig. 2. In this figure, the distances belonging to test chamber are in mm range.

To get an adjustable voltage between 0-220 V a variac with a maximum power of 5 kVA is fed with 220 V/50 Hz AC input. In order to obtain high voltage, a voltage transformer having 220 V/ 40 kV turn ratio with 1,5 kVA power rating is used. The primary side or low voltage windings of transformer is supplied from the output of the variac. This configuration allowed us to obtain an adjustable high voltage at the secondary windings of the transformer in accordance with turn ratio. Fig. 3 shows the picture of the overall setup.

In order to protect the system from high current and voltage, a 1 MΩ protective resistor is used for connection after the high voltage windings [20]. The resistor is connected to an electrode by using a co-axial cable. A rod-plane electrode configuration is used in this study. The rod electrode is made from brass with a diameter of 9 mm and length of 140 mm. The tip point of rod electrode is of 0.5 mm thickness. Earth

electrode has a planar plate structure with dimensions of 150x170x3 mm. This electrode is also made from brass. The chamber holding the mineral oil and pressboard is made from plexiglass material. The dimensions and wall thickness of the chamber are 300x180x220 mm and 10 mm, respectively. Care has been taken to prevent any leakage from the test chamber.

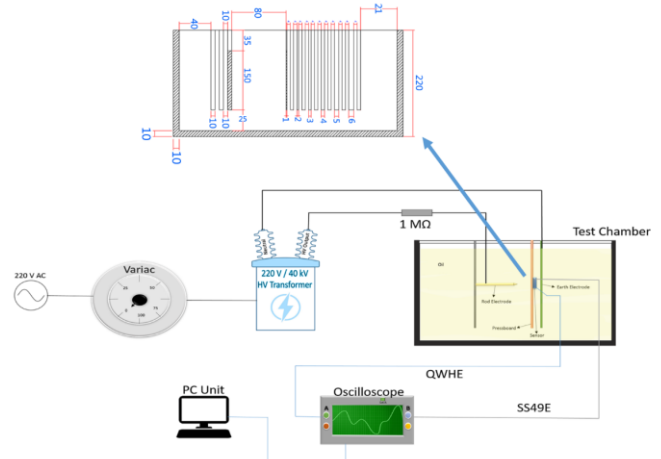

FIGURE 2. Schematic diagram of test set-up

The pressboard is of 150x170 mm dimension and it has fiber density of 1.2g/cm<sup>3</sup> and a relative dielectric constant of  $\epsilon_r = 4.1$ . The relative dielectric constant of mineral oil is  $\epsilon_r = 2.2$ . The mineral oil used is pristine. This oil is widely used as an insulator in transformer windings. The distance between tip point of high voltage electrode and pressboard is 1mm while earth electrode and pressboard have 4 mm. These distances were ensured by the specific test chamber. All these distances were adjusted exactly by the adaptive test chamber. Hence, there is no manual arrangement or adjustment to get exact distances mentioned above.

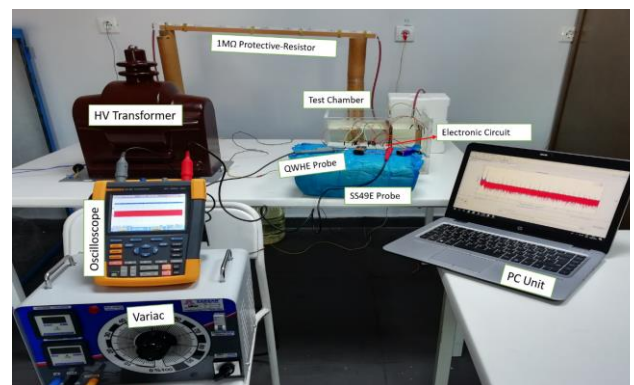

FIGURE 3. Experimental set-up

The AC magnetic field is measured by two different Hall Effect Sensors, namely, the commercially available SS49E from Honeywell [13] and the QWHE magnetic field sensors designed and fabricated by the research group at the University of Manchester [15-17]. As can be seen from Figure

2, the sensor is located exactly at the middle point of the pressboard, on the back surface where it looks at the ground electrode. The front side of the sensor is put on pressboard. Taking into consideration working voltage, current and tolerance of both sensors two different amplifier circuits, which are recommended by manufacturers, were implemented for each one separately to get more accurate measurements. These circuits are shown in Fig.4 (a) and (b), respectively. The output of an instrumentation amplifier is read by a 500 MHz bandwidth Fluke 190-504S portable oscilloscope. In addition, the oscilloscope is connected to a host PC to upload the acquired raw data.

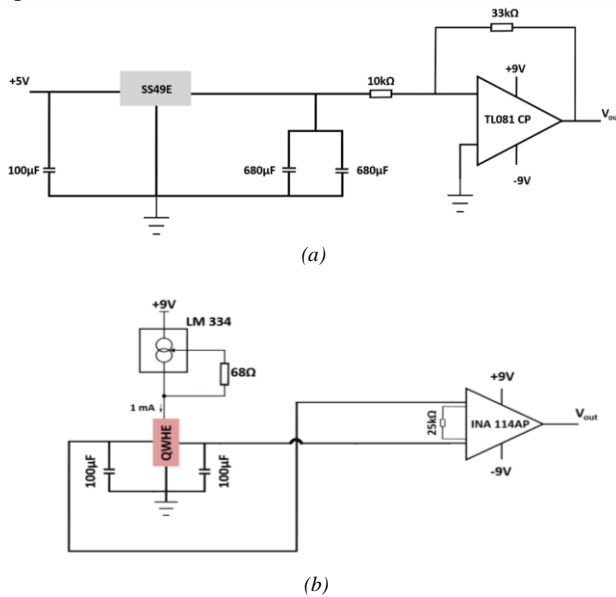

FIGURE 4. Amplifier Circuits for (a) SS49E and (b) QWHE

## IV. DECOMPOSITION METHODS

### A. WAVELET DECOMPOSITION

Wavelet Decomposition (WD) is a mathematical processing method proposed to analyze the original signals by decomposition into various frequencies/sub-layers. Wavelet transform usually decomposes a signal into an approximation component and many detail components.

A CWT for an original signal  $f(t)$  with respect to a mother wavelet function  $w(t)$  can be defined as [21,22]:

$$CWT_f = \langle f(t), \Psi_{a,b}(t) \rangle = \int_{-\infty}^{+\infty} f(t) \frac{1}{\sqrt{|a|}} \Psi^* \left( \frac{t-b}{a} \right) dt \quad (1)$$

Where  $a$  is a scale coefficient and  $b$  is a translation coefficient \* denotes the complex conjugate.

A wavelet decomposition tree showing the decomposition process is shown in Fig.5. Firstly, the signal  $s$  is decomposed into an approximation component  $a_1$  and a detail component  $d_1$ ; and then the  $a_1$  is further decomposed into another approximation component  $a_2$  and a detail component  $d_2$  and this decomposition repeats same process steps if we want to analyze the signal with higher level resolution.

### B. Empirical Mode Decomposition

The EMD (Empirical Mode Decomposition) is a time domain signal decomposing method, proposed by Huang in 1998 [23]. It not only makes the signal decomposition unique but also has good local characteristics both in time domain and frequency domain. The EMD method finds extensive applications in the power systems and renewable energy studies for preprocessing.

Given an original series  $\{Y(t)\}$ , it can be described with the following Equation (2) after the EMD calculation.

$$Y(t) = \sum_{i=1}^n C_i(t) + R_n(t) \quad (2)$$

Where  $\{C_i(t)\}$ ,  $i=1,2,\dots,n$  is the Intrinsic Mode Function (IMF) in different decompositions and  $\{R_n(t)\}$  is the residue after  $n$  numbers of IMFs are derived.

An IMF satisfies the following two properties [24]:

(i) The number of extrema and the number of zero crossing in a whole sampled data set must either be equal or differ at most by one;

(ii) At any point, the mean value of the envelope defined by the local maxima and the local minima is zero.

A sifting alternative process is employed to extract the separate components IMFs. The detailed steps of the sifting calculation can be demonstrated as follows [25]:

a) Identify all local extrema of series  $\{Y(t)\}$ , including local maxima and local minima.

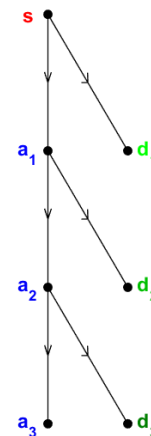

FIGURE 5. Wavelet tree schematic diagram of decomposition

b) Connect all local maxima by a cubic spline line to generate its upper envelop  $\{Y_{up}(t)\}$ . Similarly, the lower envelop  $\{Y_{low}(t)\}$  is made with all local minima.

c) Compute the mean envelop  $\{M(t)\}$  from the upper and lower envelopes by using the following equation:

$$M(t) = \frac{[Y_{up}(t) + Y_{low}(t)]}{2} \quad (3)$$

d) Extract the details as follows (Equation 4):

$$Z(t) = Y(t) - M(t) \quad (4)$$

e) Check whether  $\{Z(t)\}$  is an IMF: (i) if  $\{Z(t)\}$  is an IMF then



set  $C(t)=Z(t)$  and meantime replace  $\{Y(t)\}$  with the residual  $R(t)=X(t)-C(t)$ ; (ii) if  $\{Z(t)\}$  is not an IMF, replace  $\{Y(t)\}$  with  $\{Z(t)\}$  then repeat Steps b-d until the termination criterion is satisfied. Equation 5 can be regarded as the termination condition of this iterative calculation:

$$\sum_{t=1}^m \frac{[Z_{j-1}(t) - Z_j(t)]^2}{[Z_{j-1}(t)]^2} \leq \delta (j=1, 2, \dots; t=1, 2, \dots, m) \quad (5)$$

Where  $m$  is the length of signal,  $\delta$  is the terminated parameter, which is usually set as 0.2-0.3, and  $j$  denotes the times of iterative calculation. The  $\delta$  is usually determined by the requirements of applications.

f) The procedure of steps a-e is repeated until all IMFs are found.

## V. RESULTS AND DISCUSSION

In this section, the performance of the SS49E and QWHE sensors in the context of partial discharge detection has been analyzed. Figure 6 shows comparison of a time window captured by SS49E and QWHE sensors. The partial discharge signals observed when a 14.5 kV voltage level is applied are shown in the Figure 6. The reason of selecting this voltage level is an important side of the experiment, because if higher voltage levels applied to the insulators, hall effect sensors are burn due to exceeding electrical discharges. While the QWHE sensor detects all different types of signals that are PD and shielding detected in the experimental setup, it is seen that the SS49E sensor makes a nearly sinusoidal constant detection at a maximum value around 2.5 mV. Considering that the partial discharge signals are suddenly changing with time, it can be seen that the signals seen at points (a) and (b) are easily captured by the QWHE sensor. The most important problem here is determining the types of the (a) and (b) signals. Although the amplitudes are different in Figure 7, it can be seen that the (b) signal is repeated in the same time periods.

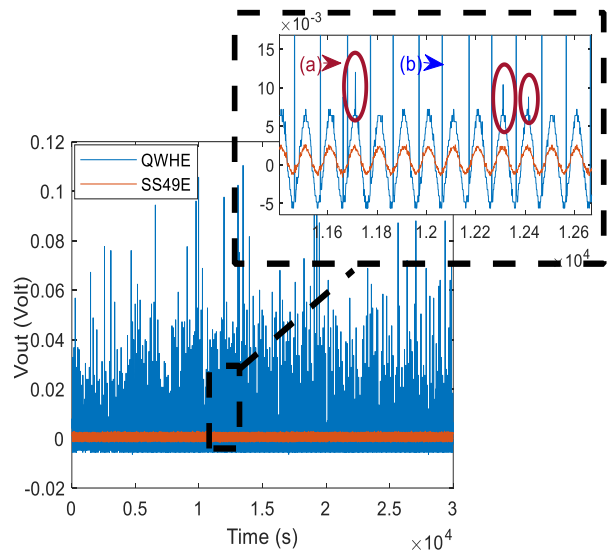

FIGURE 6. The test results of QWHE and SS49E

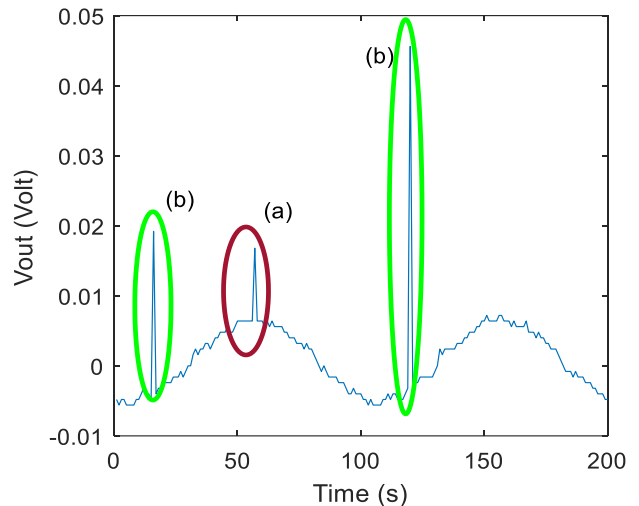
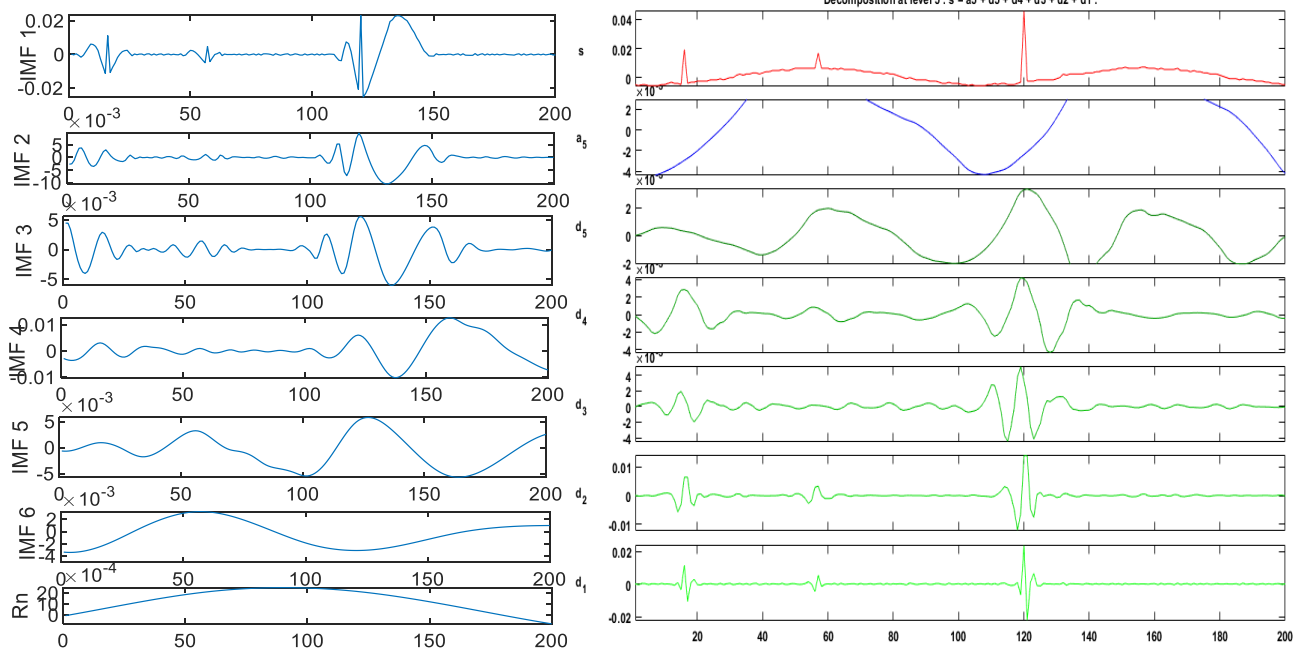

FIGURE 7. PD and shielding signals of the experimental setup with QWHE



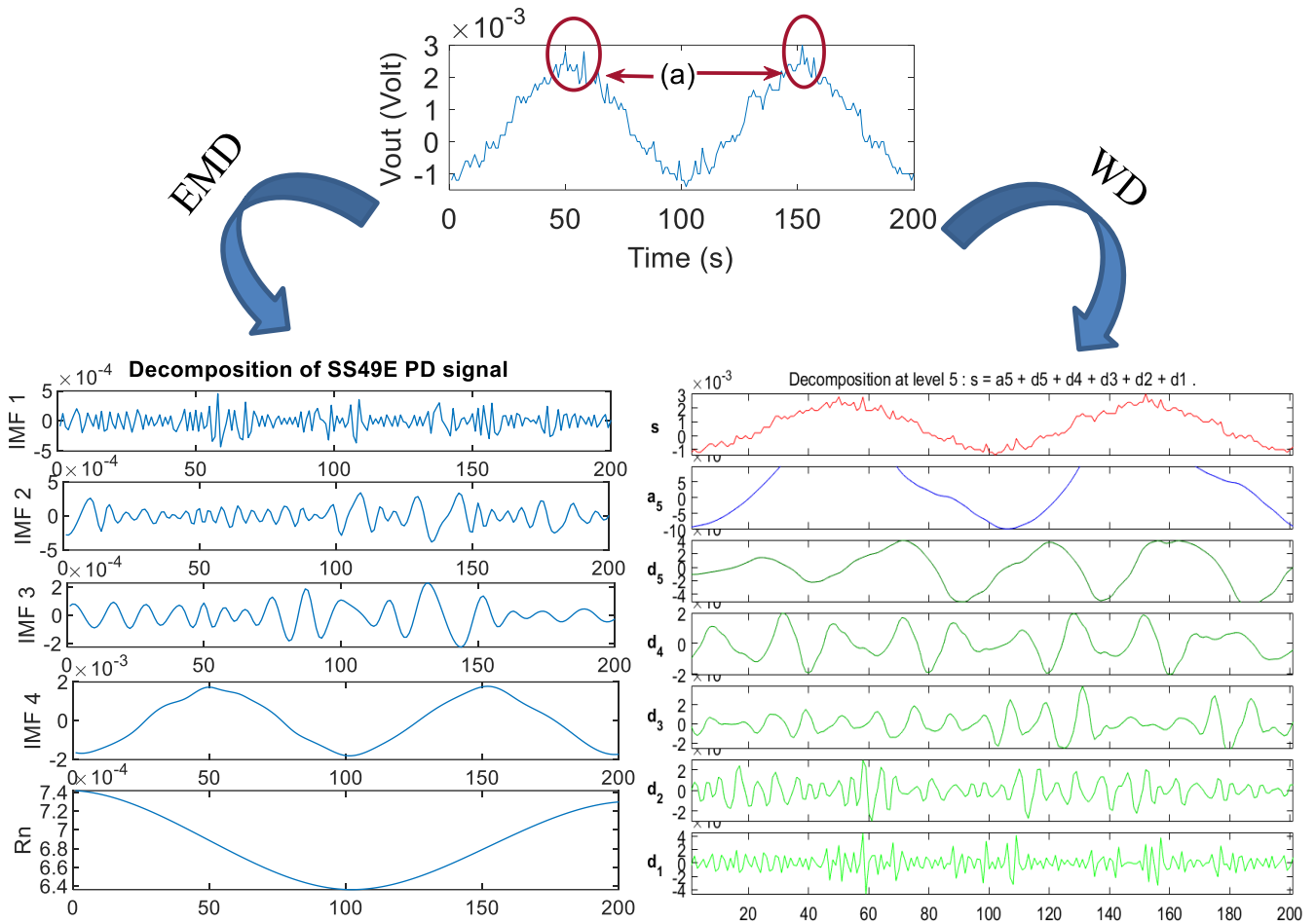

FIGURE 9. Decomposition Signal Using EMD and WD for SS49E

This shows that there is a signal originating from the shielding and measurement system in the experimental setup. However, the excessive ripple at the point of maximum value of sinusoidal signal can be interpreted as PD signal (a) of mineral oil. In order to detect and analyze the PD signals in detail, the decomposition process was made using EMD and WD. In Figure 8, the signal containing the PD signal in a certain period captured and read by the QWHE sensor is decomposed by both methods.

As seen in Figure 8, the PD signal for decomposed components were easily detected at about 57 ms. Signals resulting from screening (b) were observed at 18 and 120 ms by decomposing from the main component. The main advantage of using such decomposition methods is that the suddenly changing/ripples in PD signal can be extracted. As seen in Figure 8, the PD signal for the circuit made using the QWHE sensor gives early information about the deterioration in mineral oil that has just started. The amplitude of the PD signal is 16.8 mV (nearly 95 mT), which indicates that the stress caused by the electric field in the oil has increased.

In Figure 9, EMD and WD decomposed forms of the PD signal read from the SS49E sensor are given.

Although PD signals specified at the (a) points were detected in experiments using SS49E, the characteristics of these signals do not give clear information about the electrical degradation behavior of the mineral oil. For this reason, the characteristics of the PD signals cannot be clearly seen in the decomposed signals. PD signals measured with SS49E do not provide clear information for mineral oil in the deterioration process towards electrical discharge. The magnitude of PD signal captured by SS49E is 2.5 mV (0.6 mT). Because the amplitude of the PD signal observed with the QWHE sensor is higher, it can be interpreted as the existence of a serious PD event in the measurement setup. Considering the properties of the signals caused by the screening, although it shows an initial characteristic for the PD, these signals cannot be characterized with the similar feature due to their repetition in the same periods. However, these signals still show that there is a PD event taking place. In the measurement with this sensor, the PD was detected, but its amplitude does not clearly reveal the dielectric behavior of the oil.

## VI. CONCLUSION

The presence of partial discharges is the most significant factor that gives clues about transformer operating performance and efficiency. If these discharges take a long time, the oil insulator between the windings can be completely exposed to electrical breakdown. In this study, partial discharges occurring in transformer mineral oil were successfully monitored by using a highly sensitive QWHE sensor. The obtained experimental comparative results of the signals received from two different sensors (SS49E and QWHE) were analyzed by using different signal decomposition methods (WD, EMD). It was demonstrated that the QWHE sensor detects PD signals in a more sensitive range than the SS49E. In future studies, our aim is to create predictive models about potential transformer failures by using artificial intelligence methods using QWHE sensor-based real time PD measurements on power transformers in actual operation.

## REFERENCES

- [1] F. Atalar, "Investigation Of The Partial Discharge On Pressboards Immersed In Mineral Oil," Master Thesis, Istanbul University, Institute of Graduate Studies in Science and Engineering, Turkey, 2018.
- [2] P. M. Mitchinson, P. L. Lewin, B. D. Strawbridge, and P. Jarman, "Tracking and surface discharge at the oil-pressboard interface," *IEEE Electr. Insul. Mag.*, vol.26, no. 3, pp. 35-41, 2010.
- [3] F. Atalar, C. P. Uzunoğlu, S., Cekli, and M. Uğur, "Statistical analysis of induced magnetic fields on oil-impregnated insulation pressboards," *Electr Eng*, vol.102, pp. 2095–2107, 2020.
- [4] H. Zainuddin, P. L. Lewin and P. M. Mitchinson, "Partial discharge characteristics of surface tracking on oil-impregnated pressboard under AC voltages," *IEEE International Conference on Solid Dielectrics (ICSD)*, Bologna, 2013, pp. 1016-1019.
- [5] J. Li, W. Si, X. Yao and Y. Li, "Partial discharge characteristics over differently aged oil/pressboard interfaces," *IEEE Transactions on Dielectrics and Electrical Insulation*, vol. 16, no. 6, pp. 1640-1647, 2009.
- [6] K. Gülnihar, "Developing A Novel Method For Partial Discharge Measurement And Location In Transformers," PhD Thesis, Istanbul University, Institute of Graduate Studies in Science and Engineering, Turkey, 2017.
- [7] K. Gülnihar, S. Cekli, C. P. Uzunoğlu, and M. Uğur, "Location estimation of partial discharge-based electromagnetic source using multilateration with time difference of arrival method," *Electr. Eng.*, vol. 100, pp. 839–847, 2018.
- [8] Y. Shibuya, S. Matsumoto, T. Konno and K. Umezu, "Electromagnetic waves from partial discharges in windings and their detection by patch antenna," *IEEE Transactions on Dielectrics and Electrical Insulation*, vol. 18, no. 6, pp. 2013-2023, 2011.
- [9] S. Ait-Amar and D. Rogera, "Prospective method for partial discharge detection in large AC machines using magnetic sensors in low electric field zones," *IET 8th International Conference on Computation in Electromagnetics (CEM 2011)*, Wroclaw, 2011, pp. 1-2.
- [10] E. Önal, "Corona Identification of Impulse Voltage and Current," *Electrica*, vol.18, no.1, pp. 78-82, 2018.
- [11] S. İlhan "Effects of RTV Coating on the Discharge Characteristics of A Suspension Glass Insulator." *Electrica*, vol.19, no.2 , pp. 173-181, 2019.
- [12] Honeywell International Inc., "SS39ET/SS49E/SS59ET Series Linear Hall-effect Sensor ICs", 005850-4-EN IL50 datasheet, February 2015.
- [13] Advanced Hall Sensors Ltd., "P2A Highly sensitive Hall Effect sensor", QWHE datasheet, December 2017.
- [14] C. W. Liang, E. Balaban, E. Ahmad, J. Sexton, and M. Missous, "A Quantum Well Hall Effect linear isolator with wide frequency response and low gain temperature coefficient," *Sensors Actuators, A Phys.*, vol. 263, pp. 54-62, 2017.
- [15] C. W. Liang, E. Balaban, E. Ahmad, Z. Zhang, J. Sexton, and M. Missous, "A real time high sensitivity high spatial resolution quantum well hall effect magnetovision camera," *Sensors Actuators, A Phys.*, vol.265, pp. 127-137, 2017.
- [16] N. Haned and M. Missous, "Nano-tesla magnetic field magnetometry using an InGaAs-AlGaAs-GaAs 2DEG Hall sensor," *Sensors Actuators, A Phys.*, vol.102, pp. 216–222, 2003.
- [17] Pressboard and Presspaper for Electrical Purpose: Part 2:Method of Test, IEC Standard 60641-2: 2004.
- [18] High Voltage Test Techniques-Partial Discharge Measurements, IEC Standard 60270:2015.
- [19] E. Kufel, W.S. Zaengl, J. Kufel, *High Voltage Engineering—Fundamentals*, 2nd ed., Elsevier: Oxford, UK, 2000.
- [20] E. Dokur, M.Kurban, "Analysis of Decomposition Preprocessing Methods for Wind Energy," 4th International Conference on Engineering Technology and Applied Sciences (ICETAS), Kiev Ukraine, 2019, pp. 309-314.
- [21] H. Liu, H. Q. Tian, and Y. F. Li, "Comparison of new hybrid FEEMD-MLP, FEEMD-ANFIS, Wavelet Packet-MLP and Wavelet Packet-ANFIS for wind speed predictions," *Energy Convers. Manag.*, vol.89, pp. 1-11, 2015.
- [22] N. E. Huang et al, "The empirical mode decomposition and the Hilbert spectrum for nonlinear and non-stationary time series analysis," *Proceedings of the Royal Society of London. Series A: Mathematical, Physical and Eng.Sci.*, vol. 454, pp. 903-995, 1971.
- [23] Z. Zhi-hui, S. Yun-lian, and J. Yu, "Short-term load forecasting based on empirical mode decomposition and least

square support vector machine.” *Relay*, vol.35, no. 8, pp. 37-40, 2007.

[24] E. Dokur, M. Kurban and S. Ceyhan, "Hybrid model for short term wind speed forecasting using empirical mode decomposition and artificial neural network," 9th International Conference on Electrical and Electronics Engineering (ELECO), Bursa, 2015, pp. 420-423.

[25] Aydogan, A.; Atalar, F.; Ersoy Yilmaz, A.; Rozga, P. "Using the Method of Harmonic Distortion Analysis in Partial Discharge Assessment in Mineral Oil in a Non-Uniform Electric Field." *Energies* 2020, 13, 4830. <https://doi.org/10.3390/en13184830>



**FATİH ATALAR** received Bachelor and M. Sc. Degrees in Electrical & Electronics Engineering from Istanbul University, in 2015 and 2018 respectively. Currently he is working as a Research Assistant in the Electrical & Electronics Engineering Department of Istanbul University Cerrahpaşa. His main research interests are tracking in high voltage dielectric materials, lighting and magnetization.



**EMRAH DOKUR** received the B.Sc. in Electrical and Electronics Engineering, Istanbul University, Turkey in 2010 and M.Sc. degrees in Electrical Engineering, Istanbul Technical University, Turkey in 2013. He received the Ph.D. degree at Energy Systems Engineering in Bilecik S.E. University. Since 2017, he has been an Assistant Professor with the Electrical Electronics Engineering Department in the same university. He is also currently a Post Doctoral Researcher at Marine and Renewable Energy Centre (MaREI), University College Cork, Ireland. His current research interests include high voltage engineering, renewable energy systems, and power system analysis. Dr. Dokur received the Postdoctoral Fellowship Award from the Scientific and Technological Research Council of Turkey in 2020 to conduct research in the Ireland.

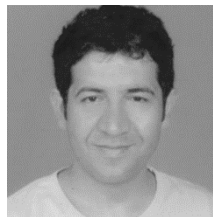

**ERTAN BALABAN** ERTAN BALABAN received a BSc and MSc. Degree from Istanbul Technical University, Turkey, in 2001 and 2005, respectively, and obtained his Ph.D. in Physics in 2013 from Gebze Technical University, Turkey. From 2007 to 2014 he worked for the The Scientific and Technological Research Council of Turkey as a research engineer. From 2014 to 2021 he

worked as a research associate and research engineer at the University of Manchester and University of Oxford. Currently, he is working as a research scientist for a private company.



**MOHAMED MISSOUS** is a Professor of semiconductor materials and devices with the School of Electrical and Electronic Engineering, University of Manchester. His research activities are centred on the growth of complex multilayer semiconductor films by the technique of molecular beam epitaxy (MBE). He has established a large MBE and Compound Semiconductor Laboratory for materials growth, assessment equipment, compound semiconductor processing facility, and device testing. Over the years, he has concentrated

with considerable success, on establishing practical approaches and techniques required to meet stringent doping and thickness control, to sub monolayer accuracy, for a variety of advanced quantum devices, from room temperature operating mid infrared quantum well infrared photodetectors, NanoTesla magnetic imaging using ultrasensitive 2DEG for nondestructive testing, and 77 GHz car radars to Terahertz materials. He is currently concentrating on the manufacturability of quantum devices including tunnel structures. He is a fellow of the Royal Academy of Engineering, Institute of Physics, and IET..He was a recipient of the 2015 Royal Society Brian Mercer Award for manufacturability of tunnel devices together with Prof. M. Kelly, He is regularly invited to give talks at international venues on mm-wave and THz technologies. His involvement in the above research topics has led to the publication over 240 papers in the open, international literature.



**MUKDEN UGUR** received an M.Sc. Degree from UMIST in 1993 and obtained his Ph.D. in Electrical Engineering in 1997 from University of Manchester, UK. From 1995 to 1996 he worked for the National Grid Company as a research assistant at the University of Manchester in the subject of analysing the breakdown process in transformer boards. Currently he is working as a Professor in the Electrical & Electronics Engineering Department of Istanbul University-Cerrahpasa. His

main research interests are tracking in polymeric dielectric materials, power systems protection, fractal modelling and statistical evaluation of breakdown.